

### Features

- 4-inch center faucet holes.
- Overflow drain.
- Coordinates with other products in the Cimarron collection.

### Material

- Vitreous china.

### Installation

- Drop-in

### Recommended Products/Accessories

K-8998 P-Trap



ADA

CSA B651

OBC

### Codes/Standards

ASME A112.19.2/CSA B45.1

ADA

ICC/ANSI A117.1

CSA B651







OBC

### KOHLER® One-Year Limited Warranty

See website for detailed warranty information.

### Available Colors/Finishes

*Color tiles intended for reference only.*

| Color  | Code | Description  |
|--|------|--------------|
|  | 0    | White        |
|  | 96   | Biscuit      |
|  | 47   | Almond       |
|  | NY   | Dune         |
|  | 95   | Ice™ Grey    |
|  | G9   | Sandbar      |
|  | 7    | Black Black™ |

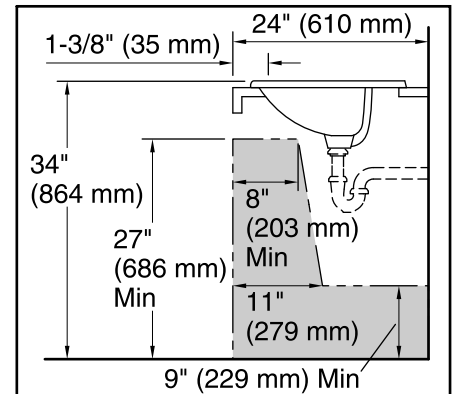
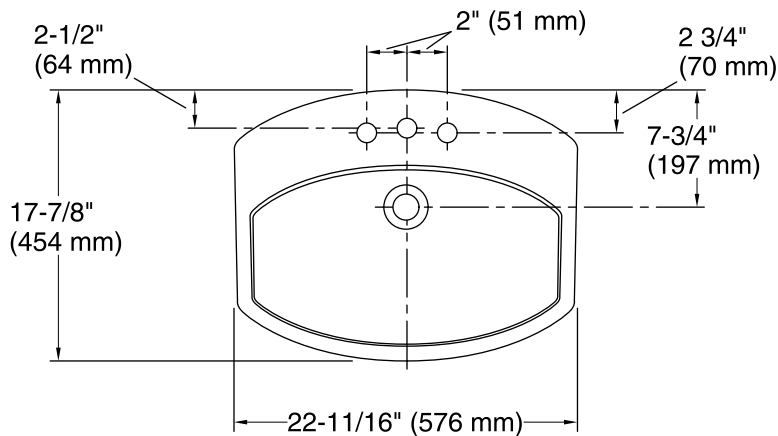

**Recommended ADA Installation**

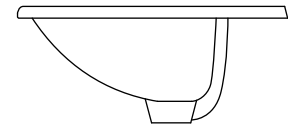
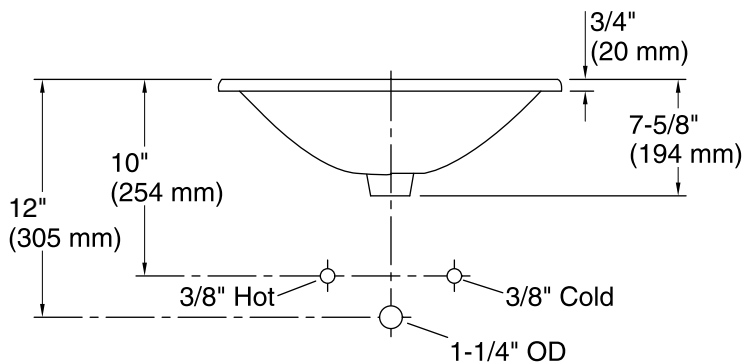

### Technical Information

All product dimensions are nominal.

- Bowl configuration: Single
- Installation: Drop-in
- Bowl area (Only): Length: 20-3/8" (518 mm)  
Width: 11-1/2" (292 mm)  
Water depth: 3-5/8" (92 mm)
- Number of deck holes: 3
- Faucet hole spacing: 4" (102 mm)
- Faucet hole(s): 1-1/4" (32 mm)
- Drain hole: 1-3/4" (44 mm)
- Template: 1017302-7, required, included

### Notes

Install this product according to the installation instructions.

**NOTICE:** Countertop manufacturer or cutter must use the cut-out template provided with the product, or a current one provided by Kohler Co. (call 1-800-4KOHLER). Kohler Co. is not responsible for cutout errors when the incorrect cut-out template is used.

ADA, OBC, CSA B651 compliant when installed to the specific requirements of these regulations.