

CODE NUMBER

3335001

DESCRIPTION

Battery Power Supply, Integrated Side Mixer, Polished Chrome Finish, 1.5 gpm, Aerated Spray, Infrared Sensor, Optima® Battery-Powered Deck-Mounted Mid Body Faucet.

DETAILS

- Flow Rate: 1.5 gpm (6 Lpm) (1.5GPM)
- Spray Type: Aerated (AER)
- Sensor Type: Infrared (IR)
- Mounting Type: Single Hole
- Power Supply: Battery (BAT)
- Temperature Mixer: Integrated Side Mixer (ISM)
- Finish: Polished Chrome (CP)
- Factory Default Timeout: 30s
- Factory Default GPC: 0.75

FEATURES

Commercial Grade, ADA Compliant, Electronic, Sensor-Activated, Cast Brass Hand Washing Faucet with the following features:

- Double Infrared Sensors with Automatic Setup and Indicator Light
- Automatic Self-adapting Sensor Technology
- Low Battery Indicator
- Magnetic Solenoid Valve
- Water Supply Connection with Flexible High-pressure Hose and Strainer
- 6 Volt Lithium 2CR5 Commercial Battery included
- Appropriate Mounting Hardware included
- Optional 24 Hour Sentinel Activation
- IQ-Click feature permits activation of continuous run and temporary off modes

ELECTRICAL SPECIFICATIONS

- Battery Life: 3 years 8,000 cycles/month
 - Optional power harvesting significantly extends service life.
- Self-Adjustment Range: 0" (0mm)
- Sensor Range: 0" (0mm)
- Timeout Adjustment Settings: 30s

DOWNLOADS

- [EAF 100/150 Installation Instructions](#)
- [EAF 100/150 \(SP\) Installation Instructions](#)
- [Faucet Spray Heads Repair and Maintenance Guide](#)
- [Optima Plus EAF 150 Repair and Maintenance Guide](#)
- [Additional Downloads](#)

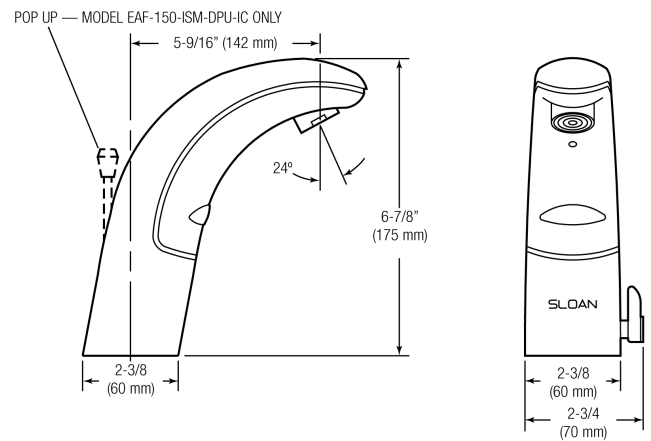

COMPLIANCES & CERTIFICATIONS

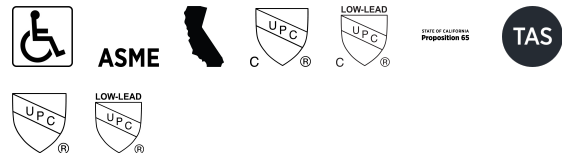

(ADA Compliant, ASME A112.18.1 Compliant, CEC Compliant, cUPC Certified, cUPC Low Lead Compliant, Proposition 65, TAS, UPC Certified, UPC Low Lead Compliant)

NOTES

All information contained within this document subject to change without notice.

Looking for other variations of the EAF-150 product? [View the general spec sheet with all options.](#)

[Find a matching soap dispenser](#) for this faucet.

[Find a compatible sink](#) for this faucet.

WARRANTY

3 Year

Sloan 10500 Seymour Ave, Franklin Park, IL 60131

Phone: 800.982.5839 • Fax: 800.447.8329 • sloan.com

ROUGH-IN

**EAF-150 AND EAF-150-IC
 Faucets with Single Line Water Supply**

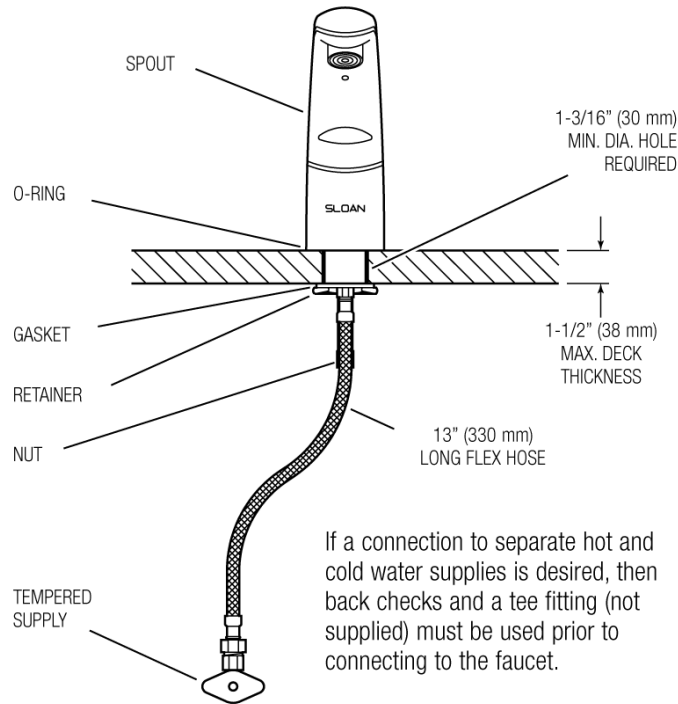

**EAF-150-ISM, EAF-150-ISM-IC AND
 EAF-150-ISM-DPU-IC
 Faucets with Hot and Cold Water Supply**

