



Features

- Alcove installation
- 3-1/2" threshold
- Solid Vikrell material
- Durable high-gloss finish
- Center drain
- Pivot snap-together modular design
- Geometric backwall design
- No caulk required
- Convenient shelves

Included Components

Product consists of:

- 72245100 36" Shower End Wall Set
- 72261100 48" Shower Base
- 72262100 48" Shower Back Wall



Codes/Standards



- CSA B45.5/IAPMO Z124
- ASTM E162
- ASTM E662
- Greenguard UL 2818 - Gold
- HUD, UM Bulletin 73

Warranty – Bathing Fixtures (and) Kitchen and Utility Sinks Made of Solid Vikrell® Material

See website for detailed warranty information.

Available Colors/Finishes

Color tiles intended for reference only.

Color	Code	Description
	0	White
	96	KOHLER Biscuit

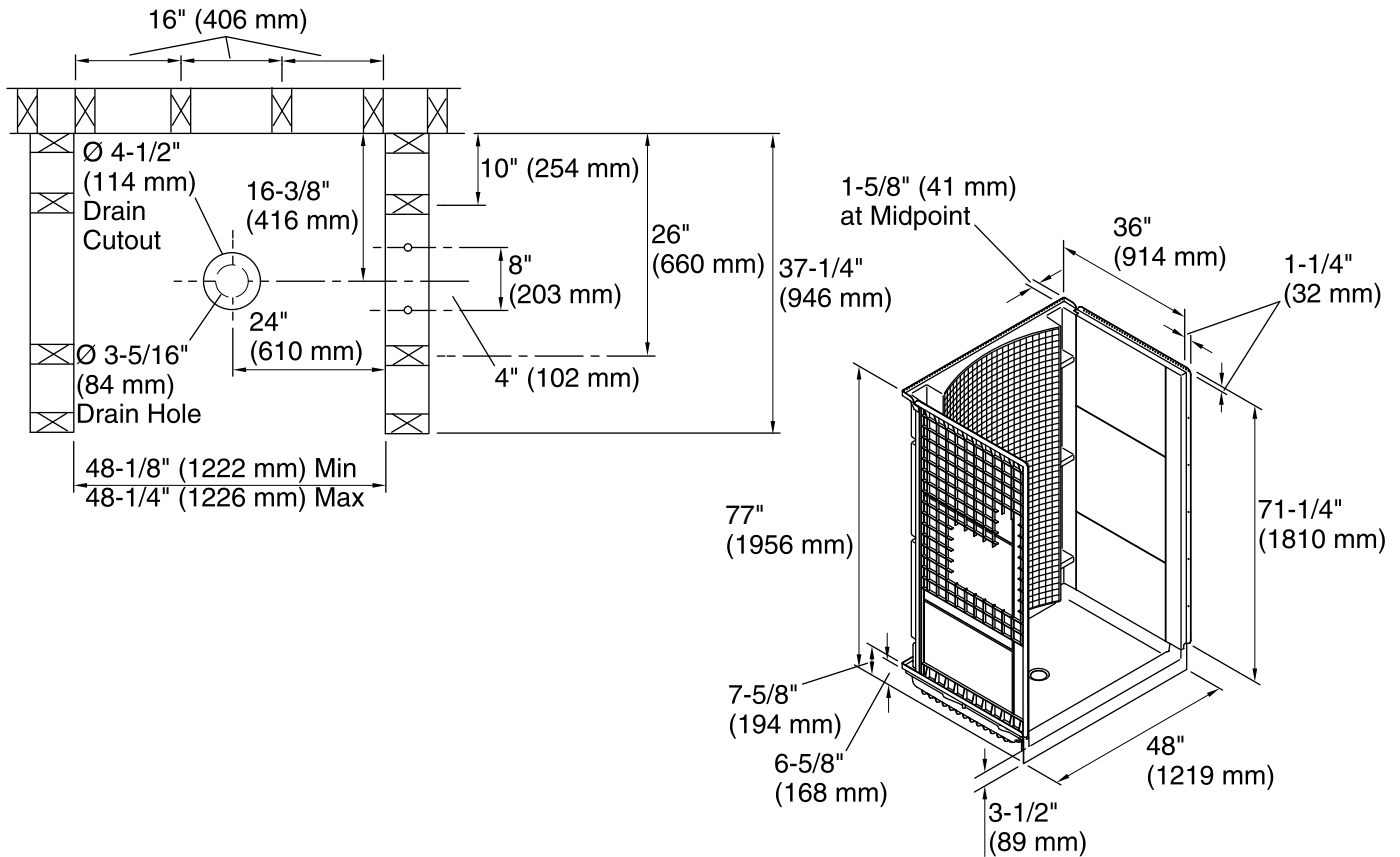

Technical Information

All product dimensions are nominal.

Installation: Three-wall alcove
 Drain location: Center
 Minimum flat for door: 3-1/4" (83 mm)
 Threshold height: 3-1/2" (89 mm)
 Maximum door height: 72" (1829 mm)
 Maximum door width: 44-5/8" (1133 mm)

Notes

Install this product according to the installation instructions.
 Studs should be positioned roughly as shown.
 Double studding is recommended for pivot shower door installations.
 Base cannot be installed without the wall surround.